



PLAINVIEW

A modern aesthetic slim profile linear light fitting that fits in well with contemporary interior design features. The double optical stages create uniform circular beam profile with minimal glare.





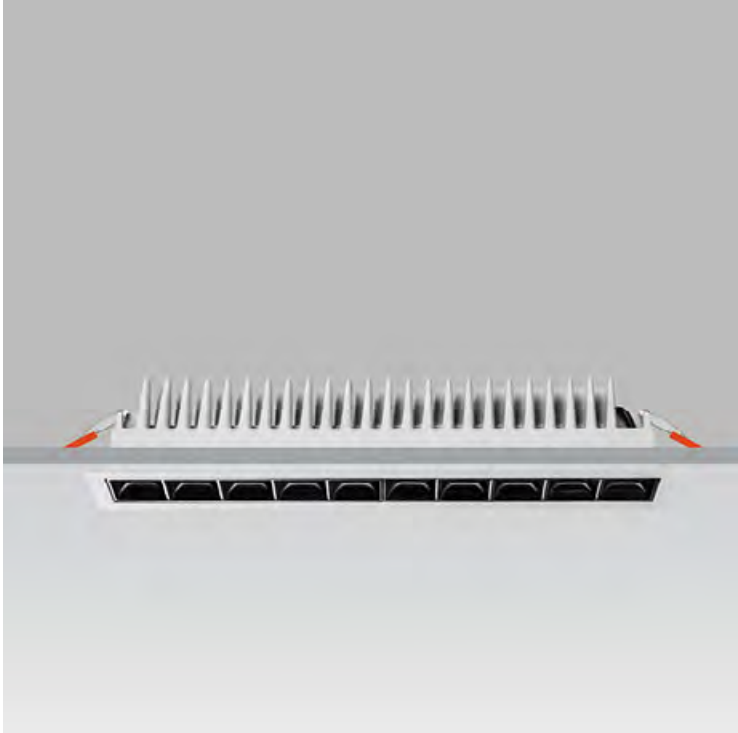

HIGH CONTRAST

The horizontal plane is perfectly illuminated, but there is no indication of where the light comes from.

PLAINVIEW



ORDER CODE	DESCRIPTION	WATTAGE	IMAGE
BM-66901	Plainview	2.1W	
BM-66902	Plainview	4.2W	
BM-66903	Plainview	10W	
BM-66904	Plainview	21W	
BM-66905	Plainview	31W	

Available in Black or White





PLAINVIEW TRIMLESS





ORDER CODE	DESCRIPTION	WATTAGE	IMAGE
BM-66911	Plainview Trimless	2.1W	
BM-66912	Plainview Trimless	4.2W	
BM-66913	Plainview Trimless	10W	
BM-66914	Plainview Trimless	21W	
BM-66915	Plainview Trimless	31W	

Available in Black





PLAINVIEW POLARISED

ORDER CODE	DESCRIPTION	WATTAGE	IMAGE
BM-66923	Plainview Polarized	9.7W	
BM-66924	Plainview Polarized	19.4W	
BM-66925	Plainview Polarized	29.1W	

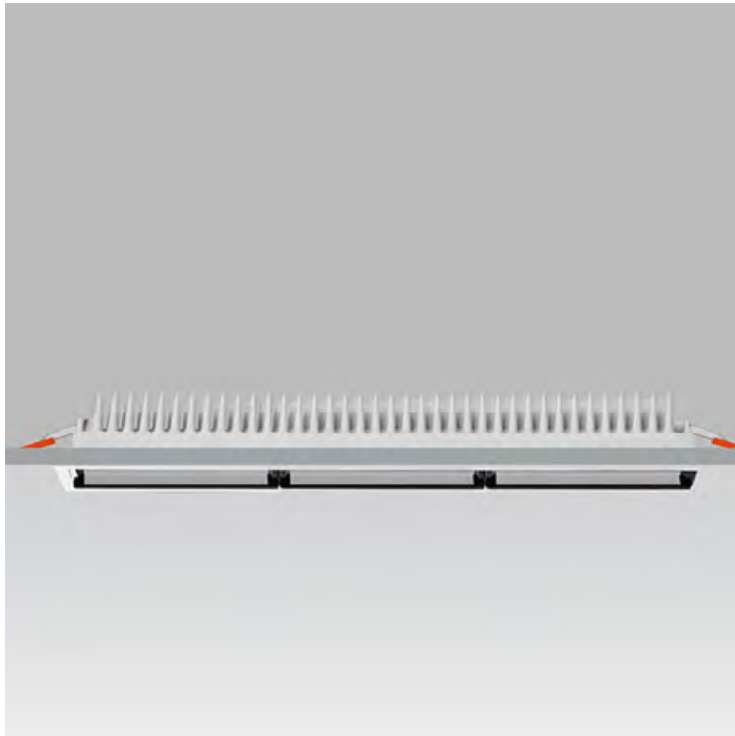



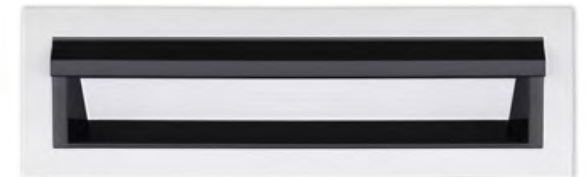

Available in Black or White



PLAINVIEW ADJ

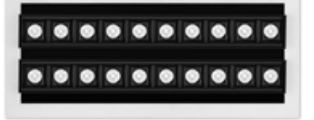

ORDER CODE	DESCRIPTION	WATTAGE	IMAGE
BM-66934	Plainview Adj	21W	
BM-66935	Plainview Adj	31W	
BM-66944	Plainview Adj	2 x 21W	
BM-66945	Plainview Adj	2 x 31W	

Available in Black or White



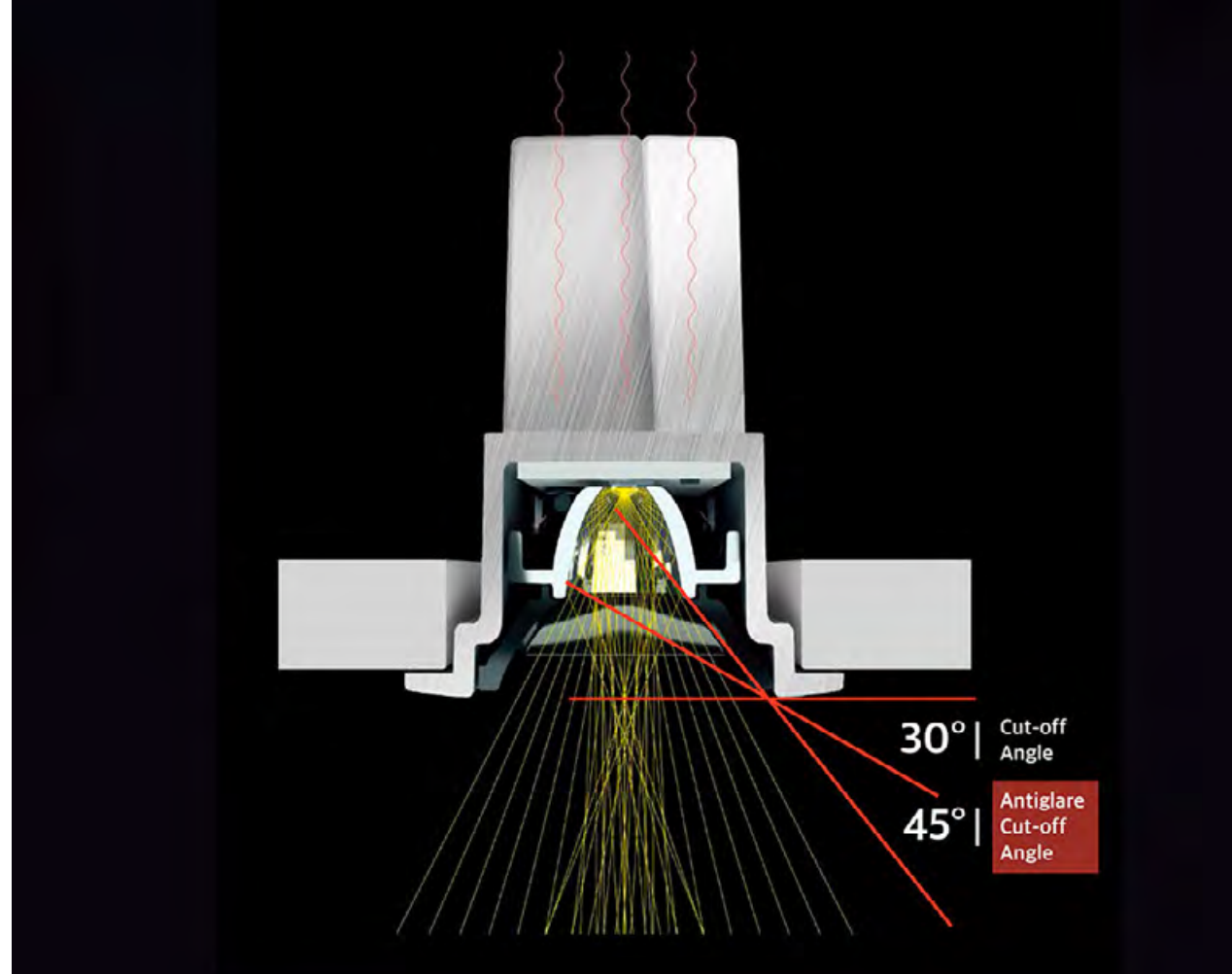

COB Options

OSRAM | Ra93, 3 Steps

Color Temperature

2700K

3000K

4000K

Beam Angle Options

Narrow Spot: 15°

Narrow Flood: 30°

Flood: 45°